

Features

- Overhanging lid design creates a clean and sleek look.
- Quiet-Close™ elongated seat closes quietly.
- Grip-Tight bumpers hold seat firmly in place.
- Quick-Release™ hinges allow seat to be unlatched from toilet for easy removal and convenient cleaning; no tools required.
- Quick-Attach® hardware for fast and secure installation.
- Color-matched plastic hinges.
- Round closed-front seat.
- Contoured seat for user comfort.
- Elegant lid design for a clean and sleek aesthetic.

Material

- Plastic construction.

Installation

- For nonresidential application, K-7673, K-20111, or K-25302 is recommended.



Codes/Standards









None Applicable

KOHLER® One-Year Limited Warranty

See website for detailed warranty information.

Available Colors/Finishes

Color tiles intended for reference only.

Color	Code	Description
	0	White
	96	Biscuit
	NY	Dune
	95	Ice™ Grey
	G9	Sandbar
	K4	Cashmere
	58	Thunder™ Grey
	7	Black Black™

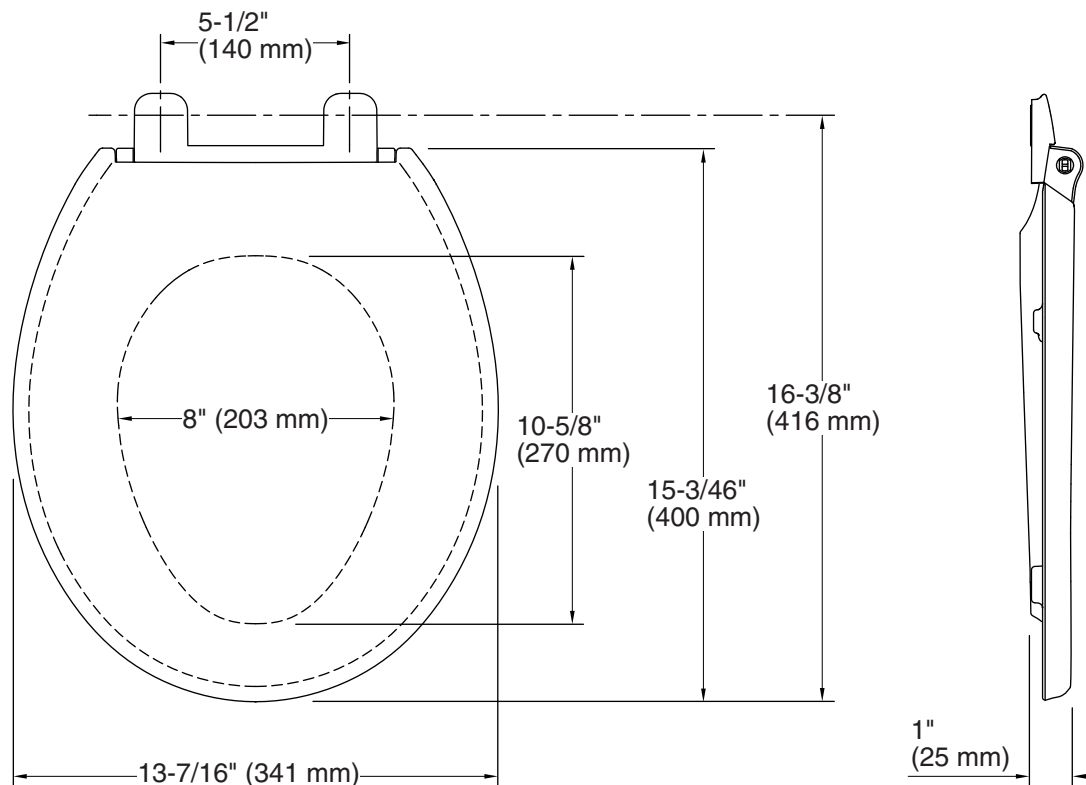

Technical Information

All product dimensions are nominal.

Seat shape type: Round-front
Seat front type: Closed-front
Seat-mounting holes: 5-1/2" (140 mm)

Notes

Install this product according to the installation guide.