

Features

- Innovative roller design simplifies installation and provides out-of-plumb adjustability while glass is installed.
- Cushioned center guide provides smooth, quiet sliding action.
- Vertical blade handles accentuate the contemporary style.
- CleanCoat®+ glass coating creates a hydrophobic barrier that repels water, soap scum, and residue, saving time and protecting shower doors 10 times longer than original CleanCoat. (Based on 2021 internal wear/abrasion testing using a microfiber cloth.)

Material

- Frameless, 5/16" (8mm) thick Crystal Clear tempered glass.

Installation

- Sliding shower door.
- Not for use in hospitality.
- For residential use only.

Included Components

Additional Components:
Hardware kit



Codes/Standards

ANSI Z97.1
CPSC 16CFR 1201

KOHLER® One-Year Limited Warranty

See website for detailed warranty information.

Available Colors/Finishes

Color tiles intended for reference only.

Color	Code	Description
	SHP	Bright Polished Silver
	NX	Brushed Nickel
	2MB	
	ABZ	Anodized Dark Bronze
	BL	Matte Black

Available Glass Options

Code	Description
L	Crystal Clear

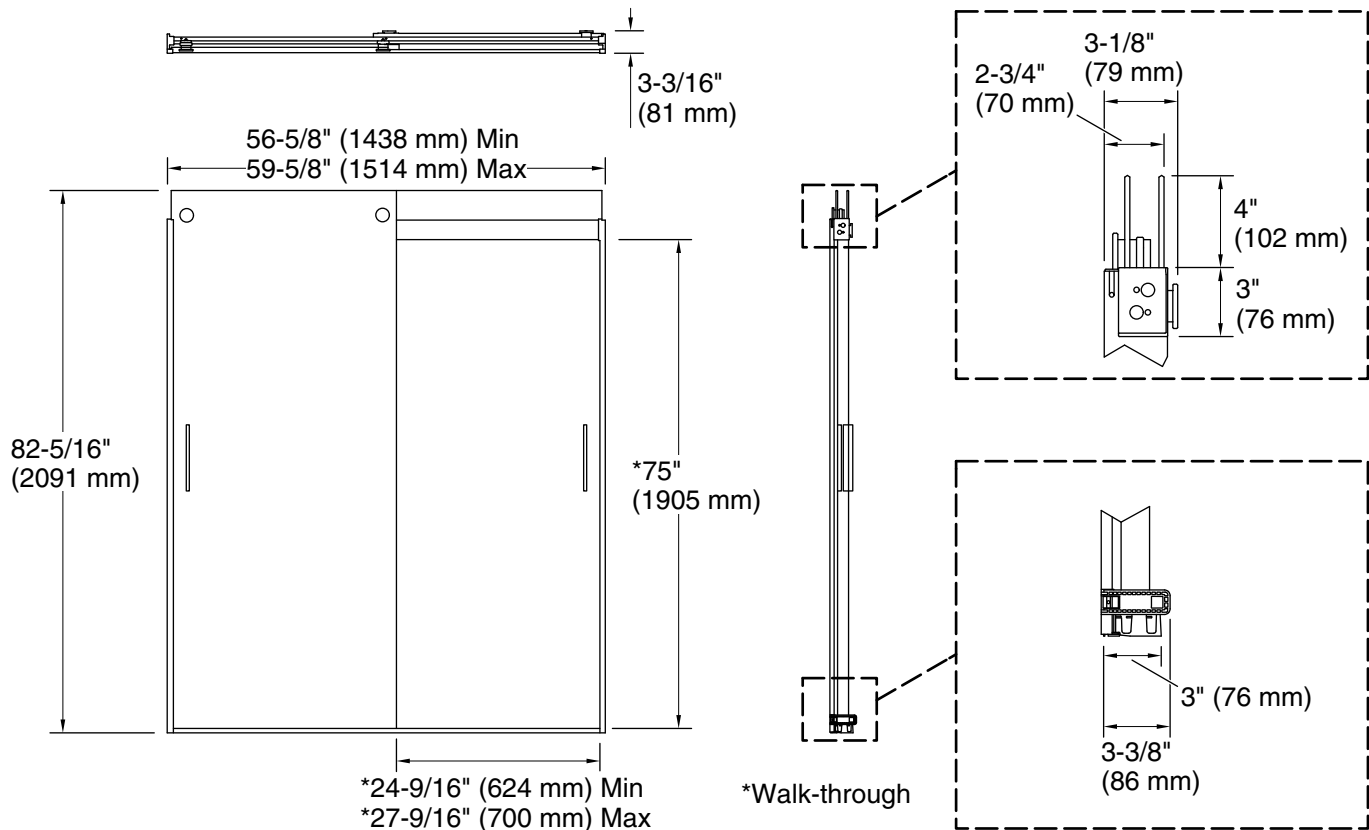

Technical Information

All product dimensions are nominal.

Installation type:	For shower base installation
Opening style:	Sliding/Bypass
Opening Width - Min:	56-5/8" (1438 mm)
Opening Width - Max:	59-5/8" (1514 mm)
Walk-through - Min:	24-9/16" (624 mm)
Walk-through - Max:	27-9/16" (700 mm)
Base-To-Wall Radius - Max:	1/2" (13 mm)
Glass thickness:	5/16" (8 mm)
Glass coating:	CleanCoat®

Notes

Install this product according to the installation guide.

The vertical opening should be a minimum of 84-1/2" (2146 mm) to allow for installation clearance.